

# PHILIPS

CoralCare LED  
Fixture

Gen2



Gebbruiksaanwijzing  
Notice d'emploi  
Benutzerhandbuch  
User manual  
Manual de usuario

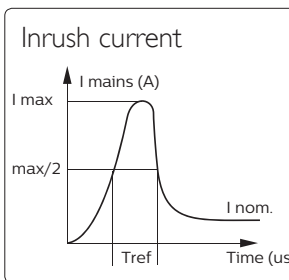
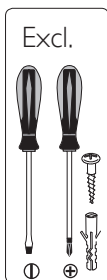
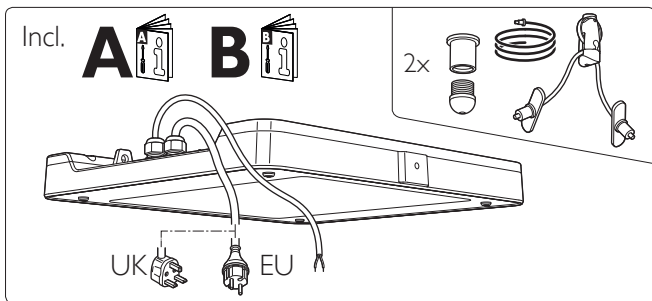

Electrical characteristics

$I_{max}$ (A)	58
Tref ( $\mu s$ )	340
MCB	Downlights Max.
B-10 A	4
B-16 A	7
B-10 A	7
C-16 A	11

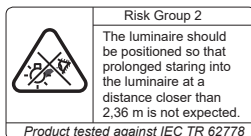
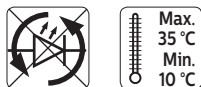
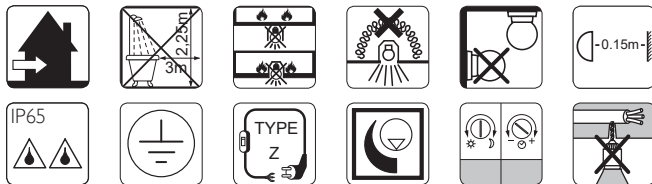

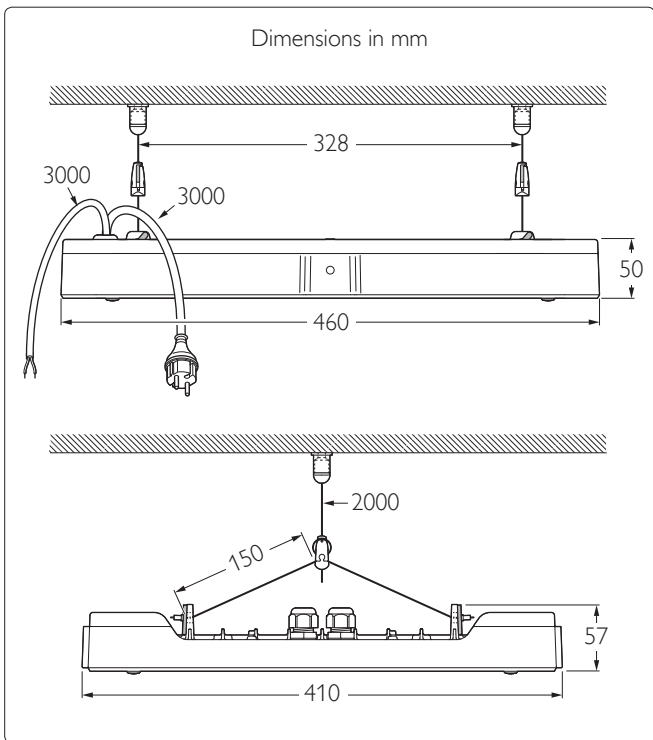
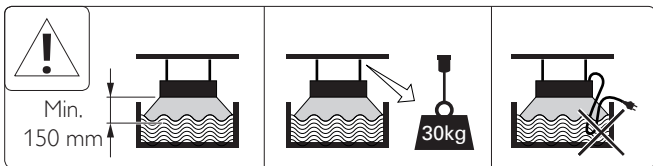

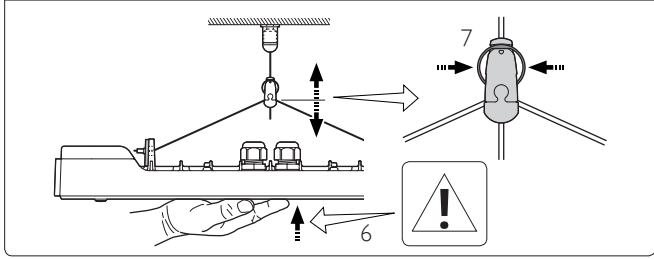
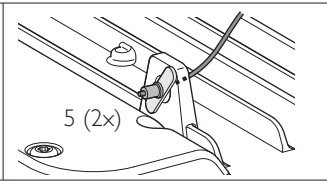
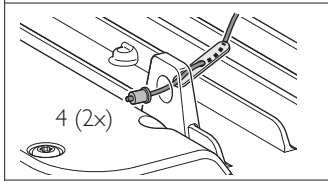
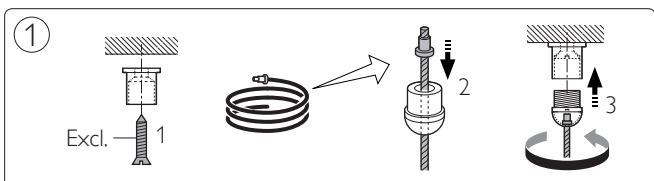
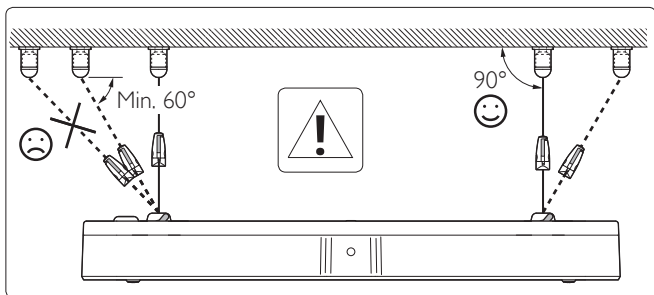

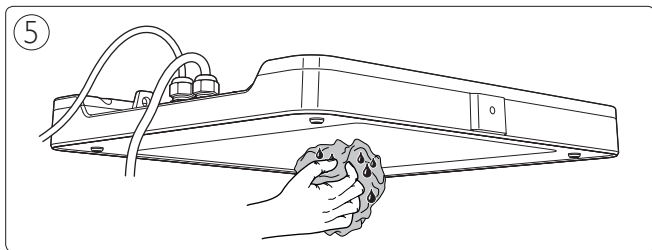
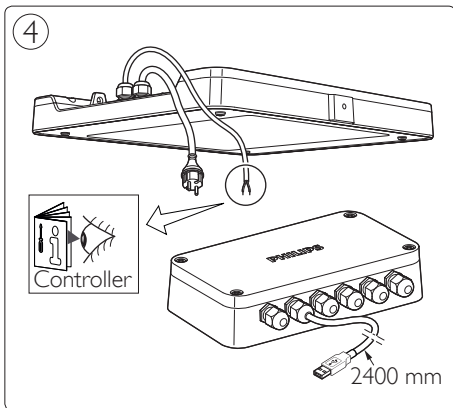
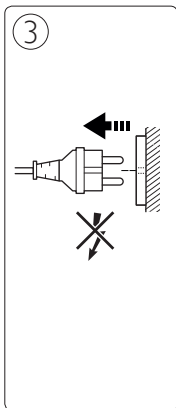
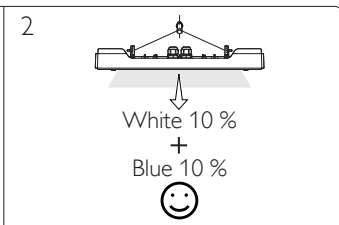
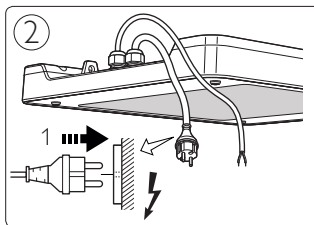



Signify  
I.B.R.S. / C.C.R.I. Numéro 10461  
5600 VB Eindhoven, the Netherlands

[www.philips.com/coralcare](http://www.philips.com/coralcare)  
☎ +800 7445 4775

© Signify  
© 2020 Signify Holding  
All rights reserved

4443.160.22971  
Last update: 28/04/20