

Kessil

LED Aquarium Light

A360 X

Tuna Blue | Tuna Sun



Inside the Box

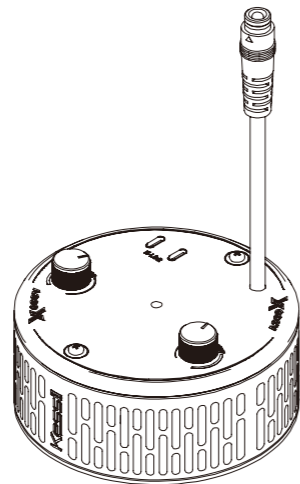

A360X x 1

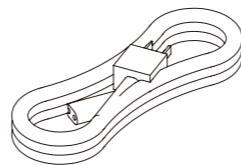

AC Adapter Cable (6 feet) x 1

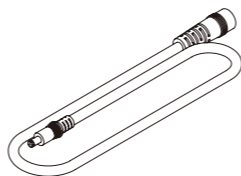

DC Power Extension Cable (6 feet) x 1

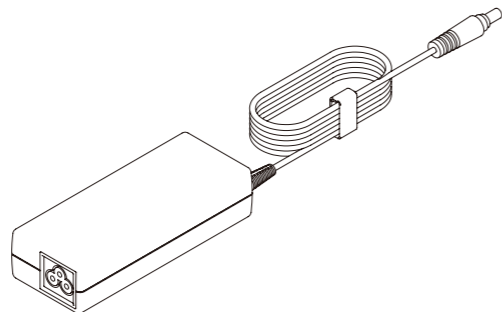

Power Adapter x 1



Hanging Bracket x 2



Hanging Ring x 1

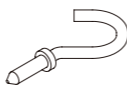

Screw Hook x 2

Parts Diagram

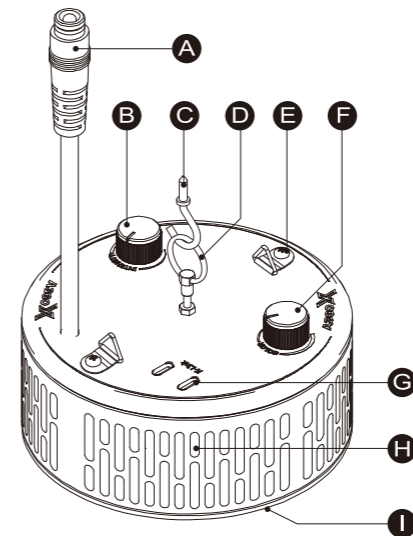

- A Power Cord
- B Intensity Tuning Knob
- C Screw Hook
- D Hanging Ring
- E Hanging Bracket
- F Color Tuning Knob
- G K-Link
- H Venting Holes
- I Lens

Safety Instructions

1. DO NOT use a power adapter that is out of the specifications. This is a fire hazard and may lead to unit failure.
2. DO NOT use outdoors. This unit is intended for indoor use only.
3. DO NOT expose unit to an extremely humid environment or submerge unit in water. This may lead to unit failure.
4. DO NOT place working illuminator in close contact with any objects. This may cause objects to heat up and the unit to overheat.
5. KEEP Lens (I) away from sharp objects. Sharp objects may break the lens and lead to unit failure.
6. DO NOT cover or place objects on the power adapter. Power adapter should not be contained in an airtight space.

Instructions de Sécurité

1. N'utilisez PAS une source d'alimentation qui est en dehors des spécifications. Ceci constitue un risque d'incendie et peut entraîner une défaillance de l'unité.
2. NE PAS utiliser à l'extérieur. Cette unité est destinée à une utilisation en intérieur uniquement.
3. NE PAS exposer l'appareil à un environnement extrêmement humide ou immerger l'appareil dans l'eau. Cela peut entraîner une défaillance de l'unité.
4. NE placez PAS l'illuminateur de travail en contact étroit avec des objets. Cela peut provoquer un échauffement des objets et une surchauffe de l'appareil.
5. GARDEZ l'objectif (I) à l'écart des objets pointus. Des objets pointus peuvent casser l'objectif et entraîner une défaillance de l'unité.
6. NE PAS couvrir ou placer d'objets sur l'alimentation électrique. L'alimentation ne doit pas être contenue dans un espace étanche à l'air.



Getting Started

Step 1 Power

Connect the A360X to the power adapter and plug it into a wall outlet. Turn the Intensity Tuning Knob (B) to the right to turn on the light.

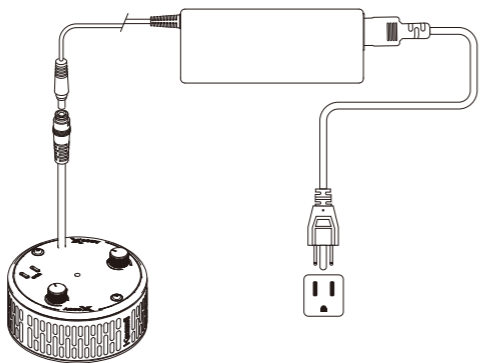

Step 2 Control

- Turn the Intensity Tuning Knob (B) to adjust the brightness of the fixture.
- Turn the Color Tuning Knob (F) to set the fixture to the desired color.
- A360X can be connected and controlled through Kessil Spectral Controller X with a Type-C USB Cable (K-Link Cable).

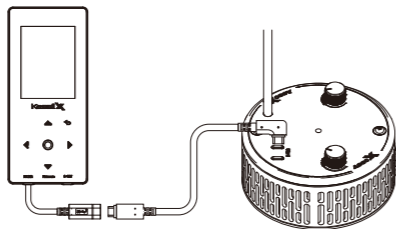

(Controller X not included)

Step 3 Controlling Multiple A360X

- Connect two or more lights with K-Link Cables as shown below.
- Multiple A360X lights can be controlled by either a single external controller or manually.
- When controlling without an external controller, tuning controls on any light control all other lights in chain.

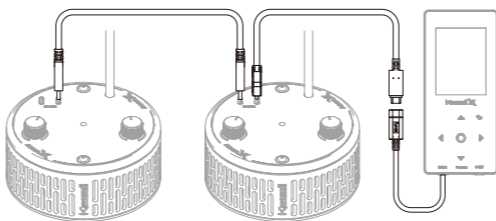

Step 4 Mounting

- Screw the Hanging Ring (D) into the center screw hole.
- Hang the light with the two Screw Hooks (C) and the two Hanging Brackets (E).
- To install the Hanging Brackets (E), remove the screws on the A360X, use the same screws to secure the fasteners with tri-hooks onto the light fixture.

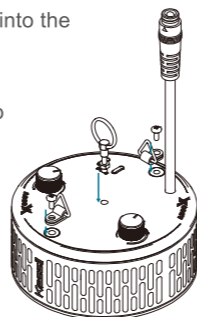

Maintenance

1. Keep the air intake holes, Venting Holes (H), and fan clear of dust. To clean the fan, unplug the unit and insert the tip of a CO2 dust blower (or similar dust blower) in one of the Venting Holes (H) on the unit's outer shell. Hold and spray. You can also gently vacuum out the light through the venting holes.
2. Keep the Lens (I) clean. If the lens becomes contaminated with water, dust, or other particles, unplug the unit and clean the lens with isopropyl alcohol. Wet a cotton swab or a napkin in isopropyl alcohol, gently wipe the surface of the lens, and let it dry.

Troubleshooting Guide

Please make sure to perform maintenance before doing any troubleshooting.

Problem	Cause / Solution
Light doesn't turn ON	Make sure the unit is connected to the power adapter and the power adapter is plugged into an outlet with the correct specifications.
	Make sure the power adapter has the right specifications.
	Make sure electrical power is available to the AC outlet being used.
Unit is flickering	Make sure the device is operating within the specified operating temperature range. If unit overheats, it will automatically shut down.
	Make sure the power adapter has the right specifications.
	Make sure the unit has not overheated by operating at a room temperature above 100°F/40°C.
	Make sure the fan is operating properly.

Product Specification

Illuminator	
Power Consumption	90W MAX
Input Voltage	19 VDC

Listed Power Adapter	
Input	100-240 VAC, 47-63 Hz, 1.5 A MAX
Output	19 VDC, 4.74A

kessil.led

kessiltube

@kessilled

kessil.com

Kessil Lighting

A DiCon Brand

1689 Regatta Blvd, Richmond, CA 94804

(510) 620-5250

www.kessil.com